

pelTM



ELECTRIC FENCE MANUAL

CONNECTING YOU AND YOUR LAND www.pel.co.nz

Contents

- TRU-TEST GROUP ELECTRIC FENCING..... 1**
- HOW AN ELECTRIC FENCE WORKS 1**
- BENEFITS OF ELECTRIC FENCING..... 1**
- WHAT TYPE OF FENCE DO YOU NEED?..... 2**
- PERMANENT ELECTRIC FENCE 3**
 - Planning the fence layout3
 - Choosing an energizer6
 - Installing an energizer7
 - Installing an earthing system8
 - Leadout from the energizer12
 - Fence posts.....13
 - Strainer post assemblies15
 - Wire17
 - Fence connections.....18
 - Gates.....18
 - Lightning protection20
 - Flood gates21
 - Electrifying a conventional fence.....22
 - Subdividing the fence.....22
- TEMPORARY ELECTRIC FENCE 23**
 - Post and wire spacings.....23
 - Temporary fencing wire/Poli-products23
 - Choosing an energizer24
 - Installing an energizer24
 - Strip grazing installations25
- FAULT FINDING 26**
 - Finding faults using a fault finder or digital voltmeter.....26
 - Troubleshooting flow chart.....28
 - Telecommunications interference.....29

© 1999-2012 Tru-Test Limited.

All product names and brand names in this document are trademarks or registered trademarks of their respective holders.

No part of this publication may be photocopied, reproduced, stored in a retrieval system, or transmitted in any form or by any means, electronic, mechanical, photocopying, recording or otherwise without the prior written permission of Tru-Test Limited. Product specifications may change without prior notice.

For more information on other quality Tru-Test Group brands and products, visit www.tru-test.com.

Tru-Test Limited
25 Carbine Road
Mt Wellington
Auckland 1060
New Zealand

Postal address:
P O Box 51078
Pakuranga
Auckland 2140
New Zealand



Tru-Test Group electric fencing

Tru-Test Group is a world leader in animal containment, livestock performance management and milk metering. We're also world leaders in electric fencing and traditional fencing tools, helping ensure animals are contained and pastures are managed for sustainable, profitable results. For more information about Tru-Test Group or our brands, visit www.tru-test.com.

We have created this manual to help you get the most from your electric fences and the best from your land.

Although there are many ways to construct an electric fence, we have outlined some of the most simple and effective methods here. For more information, see your Tru-Test Group distributor.

How an electric fence works

An electric fence energizer takes electrical energy from a power source and delivers it to an electric fence as a pulse. When an animal touches the electric fence it receives a shock.

An electric fence acts as a psychological barrier rather than a physical barrier.

Benefits of electric fencing

Electric fencing provides these benefits:

- Cost effective, requiring less labour and materials than conventional fencing.
- Easy to construct using light materials.
- Animals less likely to be injured if they breach an electric fence. Electric fences protect valuable livestock.
- Flexible - wire spacings and fence designs can be modified to control a variety of animals.
- Increases production by making it easier to subdivide paddocks.
- Fence less prone to damage because animals can't lean on the fence.
- Fence life can be extended by attaching electrified offsets (outriggers) to existing conventional fences.
- Discourages trespassers and predators.
- Environmentally friendly - quick, easy and inexpensive to fence off trees and waterways.

What type of fence do you need?

When planning your electric fencing project, consider what type of fence you need - a permanent fence or a temporary, portable fence.

The type of fence you choose will depend on many factors:

	<u>Permanent fence</u>	<u>Temporary, portable fence</u>
Best suited to	Permanent perimeter installations	Managed intensive grazing Strip-grazing
Expected fence life	20-40 years	Short term
Ease of installation	Some knowledge and special tools are required.	Simple Fast
Animals controlled	Feral animals/predators Cattle Horses Sheep Goats Pigs Exotic animals and wildlife Deer	Dairy cattle Cattle Horses Sheep
Distance	Unlimited distances	Short distances

Permanent electric fence

Planning the fence layout

Planning the layout of your electric fence will help reduce the amount of time you need to spend checking and maintaining the fence in the future. You will need to consider:

- the geography of your farm
- the type of animals being controlled
- the location of your power supply (if using a mains/line powered energizer)

The fencing plan

Here is an example of a layout for a flat, rectangular farm. The same principles can be applied to hill farms or farms of a different shape.

A lane, race or roadway down the centre or alongside the paddocks can be useful so that animals can be easily moved and checked. If necessary, water pipes can be laid down in this area.

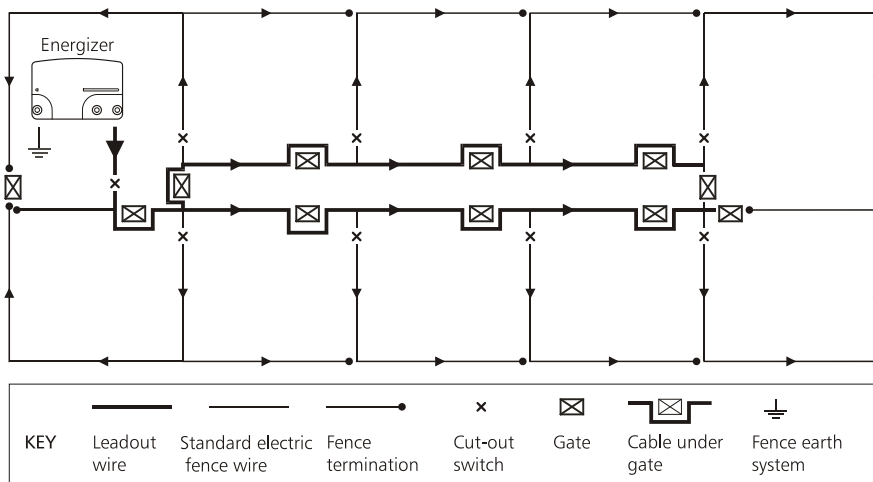

It is important to consider how the fencing plan will affect telecommunications.

Avoid a long leadout running adjacent to telephone lines. If this is unavoidable, feed the power to the fence in a 'star' fashion with no closed loops. This will ensure low currents in the sections of fence that are in close proximity to telephone lines. See *Telecommunications interference* on page 29.

Avoid creating complete loops with your fence as this will create difficulties when trying to find faults.

Energizer location

The best site for an energizer is at the hub of a number of radiating fences. This minimizes the length of each fence connected to the energizer, reducing the amount of voltage lost along the fence.

Shape of paddocks

Where possible, use square paddocks. Square paddocks utilize space better, allow for more even grazing and reduce the amount of walking required by animals. Long, narrow paddocks are often over-grazed at the front and under-grazed at the back so this shape should be avoided.

In hill country, fence to the contour so that flat areas, sunny slopes and shady slopes are all separate.

Number of paddocks

A farm should have enough paddocks to allow controlled grazing, conservation of hay and silage and long rotations during periods of slow growth. For more information about the number of paddocks required, refer to farm management software or talk to a fencing contractor.

Sheep You need enough paddocks to enable sheep to be moved daily on to a fresh paddock with up to a 3 month rotation during slow or zero growth periods. In lambing season, two or more flocks can be grazed on a faster rotation.

Dairy cows and beef cattle When longer rotations are necessary during periods of slow growth, cattle can easily be strip-grazed with only one or two wires.

Horses and deer Be sure to provide enough room for horses and deer to run around in.

Fence length

This diagram shows the length of fence required to enclose fields of different sizes. To calculate how much wire you need, multiply the length by the number of fence wires. See *Post and wire spacings* on page 4.

AREA GUIDE Length of fence required to enclose fields of different sizes

800 m (½ mile) or 160 posts	800 m (½ mile) or 160 posts	800 m (½ mile) or 160 posts	
	1 ha = 2½ acres 1 km = 5/8 mile 1 post = 5 m (16')	32.5 ha (80 acres) Requires 2.4 km (1½ miles) or 480 posts of fence to enclose	
	65 ha (160 acres) Requires 3.2 km (2 miles) or 640 posts of fence to enclose	400 m (¼ mile) or 80 posts 16.2 ha (40 acres) Requires 1.6 km (1 mile) or 320 posts of fence to enclose	200 m or 40 posts 400 m (¼ mile) or 80 posts 8.1 ha (20 acres) Requires 1.2 km (¾ mile) or 240 posts of fence to enclose
	400 m (½ mile) or 80 posts	800 m (½ mile) or 160 posts of fence 4 ha (10 acres)	100 m 2 ha (5 acres)

Post and wire spacings

Here are some suggested post and wire spacings.

Most of the fences below can have a 'ground earth return' system or 'earth wire return' system of earthing. See *Installing an earthing system* on page 8.

Fiberglass droppers or battens can be used in between fence posts to hold the fence wires in place. These allow you to space the fence posts further apart. This reduces the number of fence posts required, lowering your overall costs.

Posts only

Posts with droppers or battens

4 Wire feral

5-10 m spacing, posts only

15-20 m spacing with droppers or battens

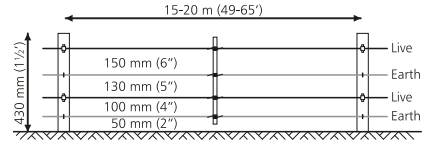
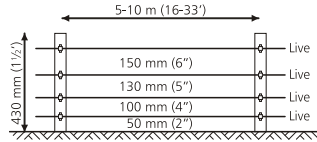

Cattle and horses

10 m spacing, posts only

15-20 m spacing with droppers or battens

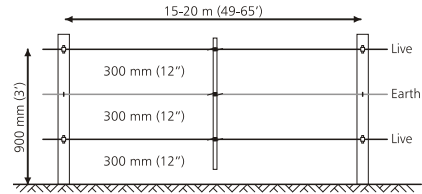
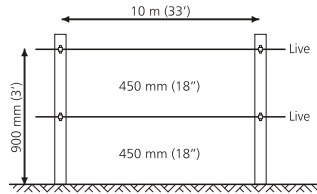

Sheep

10 m spacing, posts only

15 m spacing with droppers or battens

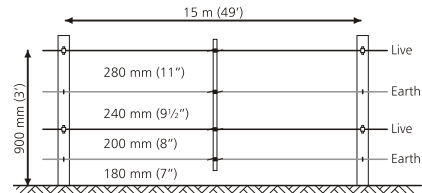
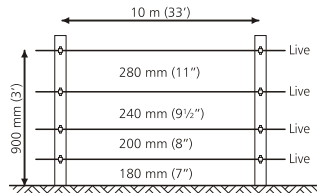

Goats and sheep

10 m spacing, posts only

15 m spacing with droppers or battens

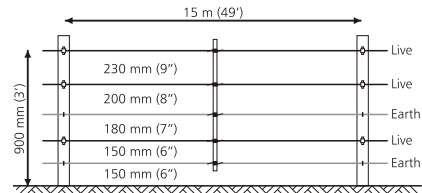
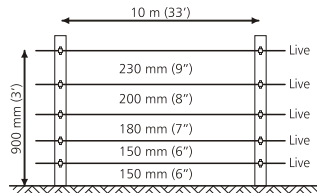

6 wire boundary or subdivision

10 m spacing, posts only

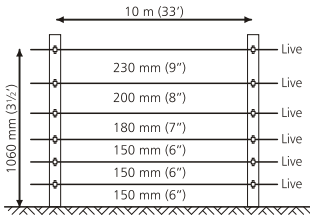

15 m spacing with droppers or battens

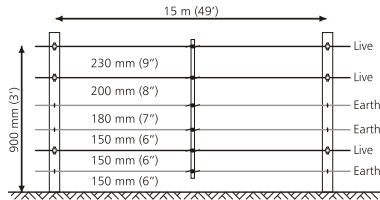

7 wire boundary

5-10 m maximum, posts only

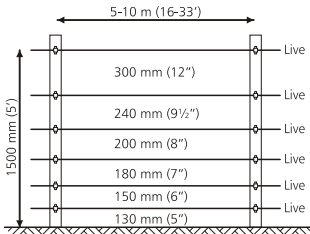

7 wire feral

10 m spacing with droppers or battens

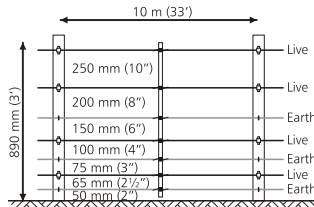

Choosing an energizer

How will you power your electric fence?

- | | |
|----------------------|--|
| Mains/line energizer | A mains/line powered energizer is the most cost-effective, reliable way to power a permanent electric fence. |
| Battery energizer | Convenient, portable and quick to set up, battery energizers are suitable for temporary, strip grazing and semi-permanent fencing. Some battery energizers are suitable to operate from a battery whilst being charged from mains/line power. Unigizers™ are also compatible with battery power. |
| Unigizer™ | A Unigizer is a flexible, all-in-one mains/line and battery energizer with solar compatibility. It is a versatile solution that works across permanent, semi-permanent and temporary fencing. |
| Solar energizer | A solar installation is ideal for isolated areas and fence lines where no mains/line power is available.
Most battery powered energizers can be fitted with one or more solar panels. Self-contained integrated solar energizers have a built-in solar panel. |

Comparing energizers

When evaluating energizers, be sure to compare them on the same basis.

Output energy the amount of energy that is delivered to the fence.

Stored energy the amount of energy stored inside the energizer. This does not necessarily relate to the amount of energy that is delivered to the fence.

It is best to compare energizers by looking at the maximum output energy.

How much fence can the energizer power?

1 joule of output energy will power approximately 10 km (6 miles) of fence wire. This will depend on the type of fence, the number of wires, climatic conditions, amount of vegetation surrounding the fence etc.

Using more than one energizer

Sometimes, dividing the fence line up into separate sections and using one energizer for each fence line may be preferable to connecting all the fence lines to one energizer. This gives more options for animal control and gives greater flexibility in farm management.

Warning! There should never be more than one energizer connected to the same fence line.

Installing an energizer

Before installing the energizer make sure you have read all the instructions provided with your energizer.

Inside installation (mains or battery powered energizer)

- Mount out of reach of children and animals.
- Mount a mains/line powered energizer near a power point.
- If possible, position the energizer in the middle of the fence.

Outside installation (battery powered energizer)

- Mount out of reach of children and animals.
- If necessary, build a protective box or fence around the energizer.
- If possible, position the energizer in the middle of the fence

Outside installation (solar powered energizers)

- Mount out of reach of children and animals.
- If necessary, build a protective fence around the solar installation.
- If possible, position the energizer and solar panel(s) in the middle of the fence.
- Adjust the solar panel(s) to face north in the southern hemisphere and south in the northern hemisphere.
- Tilt the solar panel(s) to face the midday, winter sun.
- If possible, fasten the energizer to the underside of the solar panel.

Visit www.tru-test.com to be connected to your preferred Tru-Test Group electric fence brand website, where you'll find more information about solar installations.

Installing an earthing system

What is an earth system?

The earth system consists of a number of earth rods that provide a low resistance path for the electrical current to return to the energizer's earth terminal. Larger energizers with large fence lines require more earthing rods.

How does earthing work?

For an electric fence to give an electric shock, the electrical current produced by an energizer must complete a full circuit. The current leaves the energizer and moves along the fence wires through the animal, into the soil and back to the energizer via the earth system. If the earth system is ineffective the animal will receive an inadequate shock.

What factors will affect the earth system?

Dry, sandy or non-conductive soil (e.g. volcanic soil) provides an ineffective earthing system. If you have this type of soil, it's a good idea to:

- 1 Use additional earth rods or
- 2 Choose a better location for the earth system (such as damp soil) or
- 3 Consider an alternative method of earthing such as the Earth Wire Return System.

Ground earth return system

Recommended where soil is conductive. This system is suitable for most moist soils. Current flows through the animal and the ground to the earth rods and back to the energizer to complete the circuit.

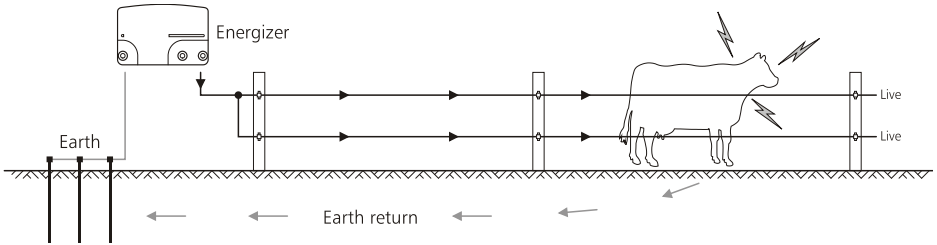

Earth wire return system

Recommended for dry, sandy or volcanic land where the ground (soil) is not conductive. The fence is constructed using both live and earth wires. If an animal touches the live wire and the earth wire at the same time, the current flows through the animal to the earth wire and back to the energizer to complete the circuit and deliver the shock.

Note: If the animal only touches the live wire it will still complete the circuit using the ground earth return, however the resulting shock may be substantially less (depending on the conductivity of the soil).

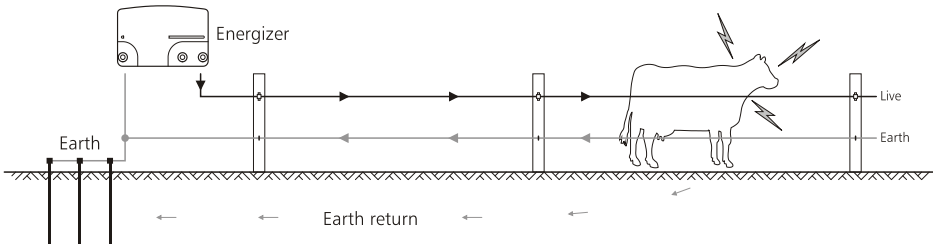

Bentonite salt earth system

A bentonite salt earth system is recommended for extremely dry soil conditions. A mixture of bentonite and salt surrounds each earth rod. The salt attracts moisture and acts as a conductor while the bentonite retains moisture over long periods of time. Stainless steel earth rods are required in order to prevent salt corrosion.

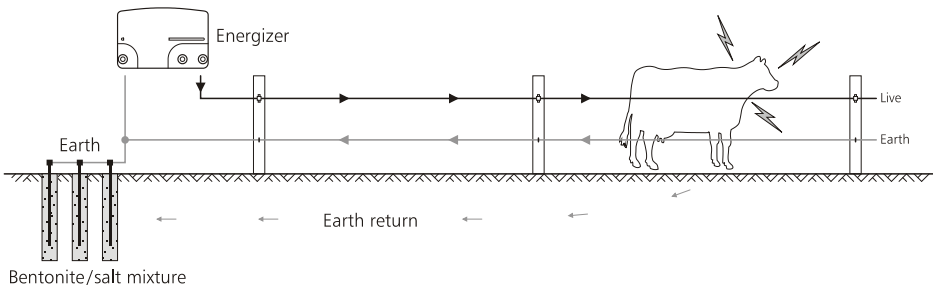

Selecting a site for the earth system

A suitable place for an earth system is:

- At least 10 m (33') away from any other earth system, e.g. house mains, underground power or phone lines.
- Away from stock or other traffic that could interfere with the installation.
- Easily be accessed for maintenance.
- Where there is damp soil all year round, e.g. shaded or swampy areas.

Tip:

- In some situations it is not possible to locate the earth system close to the energizer. As an alternative, try using the existing fence line to connect to a remote earth system.
 - It may be necessary to water the earth system in dry weather to improve soil conductivity.
-

Earth rods

The number of earth rods required depends on the type of energizer you're using to power the fence and the soil conductivity. It is recommended that you consult with your local retailer/distributor for the correct number of earth rods to suit your specific location.

- 1 Space the required number of 2 m (6'6") earth rods at least 3 m (10') apart. If using a bentonite salt earth system, space the earth rods at least 10 m (33') apart.
- 2 Ensure that the earth rods protrude out of the soil by 10 cm (3") so they can be easily connected.
- 3 Connect the earth rods in a series using earth clamps and insulated cable in one continuous length without joins.

Note: You will need to strip small sections of the insulation away from the cable to connect the earth clamp/earth rod.

Testing the earth system

To test the earth system:

- 1 Turn off the energizer.
- 2 Short circuit the fence to ground at least 100 m (330') away from the energizer. This can be done by laying steel rods or pipes against the fence. In dry or sandy soils drive the rods into the soil up to 300 mm (12").
- 3 Turn on the energizer.
- 4 Use a digital voltmeter to measure the fence voltage. It should read less than 2 kV. If not, repeat steps 1-3 using more steel rods or pipes.
- 5 Attach the voltmeter clip to the last earth rod of the earthing system
- 6 Insert the voltmeter probe into the soil at the full length of the leads.

The voltmeter reading should be no more than 0.3 kV. If the reading is higher than this, the earth system is inadequate. See the earthing checklist, add more earth rods, or find a better location for your earth system.

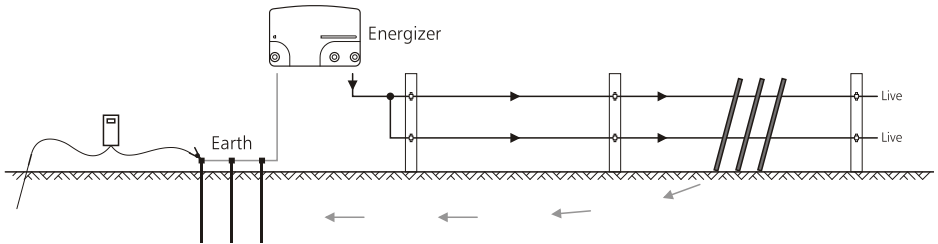

Earthing checklist

- All wires are joined securely
- Connections to earth rods are secure
- Earth rods are at least 3 m (10') apart
- Earth rods are at least 2 m (6'6") long
- There are a sufficient number of earth rods
- All parts of the earth system are made of the same metal
- The earth rods are driven deeply into the soil (100 mm [3"] exposed)
- Earth rods are a minimum of 10 m (33') away from buildings or other electrified earth systems, e.g. house mains, underground power or phone lines

Leadout from the energizer

A leadout cable or wire (a leadout) carries the electrical current from the energizer to the electric fence. It can be installed overhead or underground.

Electrical resistance results in a voltage drop between the energizer and the fence. Ideally, a leadout should have as little resistance as possible.

Factors to consider before installing a leadout:

- a shorter leadout has less resistance.
- a leadout with a large diameter has less resistance, allowing the electrical current to flow better.
- an aluminium coated leadout has less resistance than standard galvanised wire.
- an insulated leadout reduces the risk of voltage drop due to leakage such as shorts to vegetation.
- two leadouts connected in parallel will have much less resistance than a single leadout with a larger diameter.

Example: Where a long leadout is required for an energizer exceeding 10 J output, use two cables connected in parallel, aluminium leadout wire, or a larger diameter 4.0 mm (8 gauge) wire.

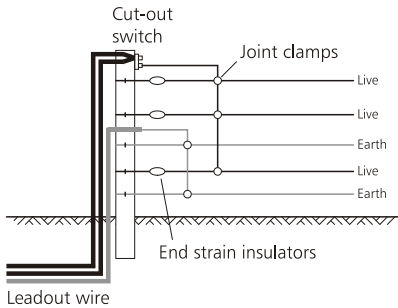

Here are some options for a leadout in order of preference:

- 1 Use a well-constructed 4-5 wire electric fence as a leadout.
- 2 Use offsets (stand-offs) or outriggers to attach a leadout to a conventional fence. Space them at 10-15 m (33-50') intervals and use 2.7 mm (12 gauge) aluminium coated wire at a height of 800 mm (2'6"), or less depending on vegetation.
- 3 As above, but use 3.15 mm (10 gauge) or 2.5 mm (12 gauge) wire.
- 4 Electrify the top two wires of an existing fence, ensuring battens and posts are insulated.

Note:

- If you have an earth wire return system, make sure that the live leadout and the earth wire cannot touch each other.
 - Keep stray wires well away from the leadout.
 - Where a leadout may come into contact with another object, use insulators or insulated tubing.
-

The table below shows the DC resistance in ohms of a single galvanised steel fence wire over 1 km ($\frac{3}{4}$ mile). The lower the resistance, the better.

<u>Wire diameter</u>	<u>Wire resistance</u>
2.7 mm (12 gauge) aluminium coated	11.5 ohms/km
4.0 mm (8 gauge)	14 ohms/km
3.15 mm (10 gauge)	22 ohms/km
2.5 mm (12 gauge)	35 ohms/km
1.6 mm (16 gauge)	90 ohms/km

Fence posts

Here are the options available for fence posts:

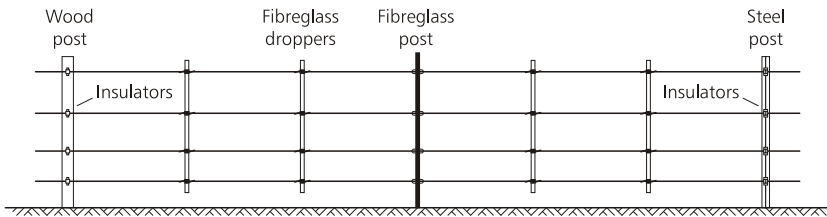

Wood posts

- strong
- rigid
- highly visible
- easy to insulate

In soft ground, wood posts can be driven straight into the soil. In hard soil, a spike can be used to form a hole before the post is inserted.

Steel posts

- strong
- rigid
- easy to insulate
- ideal for hill country terrain

Fibreglass posts

- lightweight
- flexible
- no maintenance
- no additional insulation required
- easy and fast to install
- low cost

You may also like to add droppers or battens to your fence. These have many benefits:

Droppers or battens

- these can be made of wood, plastic or fibreglass
- recommended for use with all types of fence post
- maintains wire spacing
- increases fence visibility

To attach a fibreglass dropper or batten:

- 1 Strain the fence wire to the required tension.
- 2 Bend back the wire on the fibreglass clips to release the pressure.
- 3 Position the fibreglass clip to any point on the dropper.
- 4 Attach the fibreglass clip to the fence wire.

Droppers or battens should be inserted at right angles to a slope (not vertically) in order to maintain the height of the fence and the wire spacing.

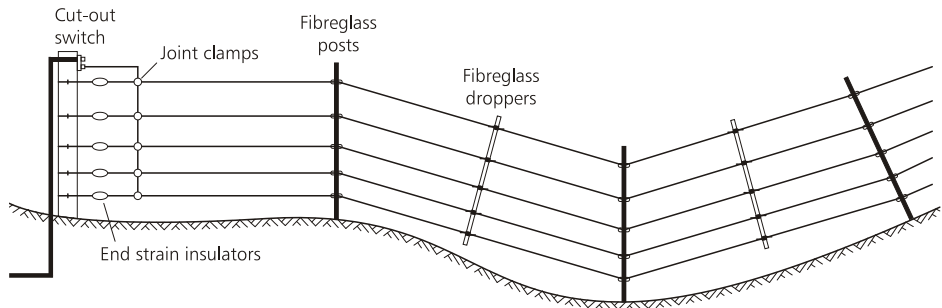

Strainer post assemblies

Strainer posts are the foundations of a fence line. Strainer posts eliminate any fence movement and will keep the fence wires taut. A wood post 2.1 m (7') high, 150 mm (6") diameter is the most suitable strainer post for an electric fence.

Any strainer assembly installed below ground will require a 'foot' wired up to the post to prevent the post rotating when the wire is strained. Use low tensile, soft wire to wire up the foot. Compared to high tensile wire, low tensile soft wire is easier to work with and will last longer underground.

There are several strainer assembly options. Make sure the option you choose can withstand the tension that will be applied to it.

Angle stay

Suitable for:

- strainer on a gate post
- high tension straining

- 1 Install a foot at the base of the strainer, wired up to the post to prevent the post rotating when the wire is strained.
- 2 Dig in a stay block just below ground level at a distance to ensure the angle stay will be held snugly in position.
- 3 Lever the stay into position with a spade.

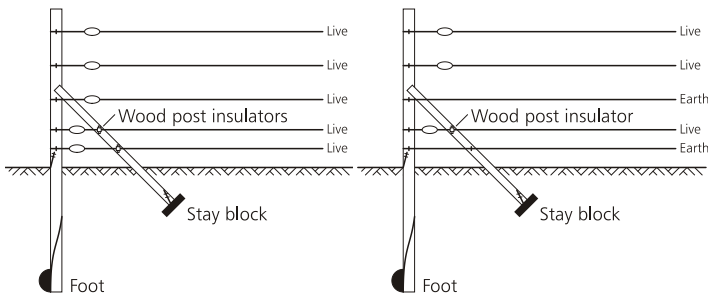

Bedlog

Suitable for:

- firm soil
- low tension straining

- 1 Install a foot at the base of the strainer, wired up to the post to prevent the post rotating when the wire is strained.
- 2 Install a bedlog (breastplate) to ensure the strainer remains in position.

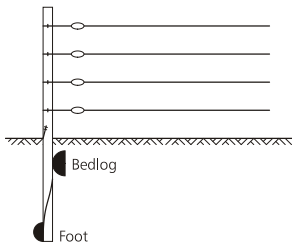

Horizontal stay

Suitable for:

- strainer on a gate post
- high tension straining
- areas with wet soil (strains above ground level)
- areas where heavy frosts occur
- controlling feral animals

A horizontal stay is simple to erect

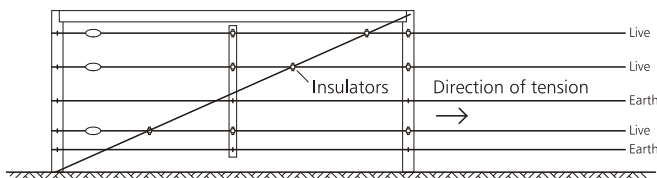

How much tension should be applied?

Electric fencing provides a psychological barrier rather than a physical one, so there is no need to excessively tension wire. Heavy strainer assemblies are not required either, reducing the overall cost of construction.

Electric fence wire should be tensioned to 90 kg (200 lb). Compare this to conventional fence wire which should be tensioned to 150 kg (330 lb). The tension of each wire can be measured using a tension meter.

Note: Increased tension may be required when controlling feral animals.

Wire

Hi-tensile wire should be used in preference to soft wire. Hi-tensile wire does not stretch or sag, and is therefore less likely to cause a fault.

2.5 mm (12 gauge) hi-tensile wire is ideal for permanent fences. Thinner gauges have greater resistance and are less effective.

Wire connecting the energizer to the fence has special requirements. See *Leadout from the energizer* on page 12.

Joining wire

Crimps are recommended for joining wires as they have good electrical contact and are almost as strong as the wire itself. Incorrectly joined wires can significantly reduce electric fence performance. For this reason, joining wire with knots is not recommended.

To crimp wires together:

- 1 Slide a crimp sleeve onto the end of the fencing wire until 6 mm ($\frac{1}{4}$ ") of wire is showing past the sleeve.
- 2 Push the wire to be joined through the opposite side of the crimp sleeve until 6 mm ($\frac{1}{4}$ ") of wire is showing past the sleeve.
- 3 Open the jaws of the crimping tool and place the jaws over the end of the crimp sleeve.
- 4 Ensure that the jaws overlap the end of the crimp sleeve slightly and that the crimping tool is at right-angles to the crimp sleeve. Compress the handles.
- 5 Slide the jaws of the crimping tool along the crimp sleeve without leaving 'shoulders' between crimps.

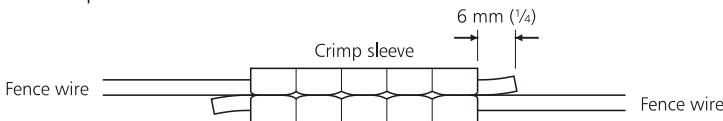

Barbed wire

Never electrify barbed wire. Why?

- Barbs may prevent a person or animal moving away from the electric fence which may result in injury or death.
- Barbs can tangle with other fence lines easily causing faults.
- Barbs can injure animals and cause damage to pelts.

Fence connections

Interconnect live wires at each end of the fence using joint clamps. Use high quality, double-insulated underground cable for connections to an earth system and beneath gates.

'Ground earth return' earth system

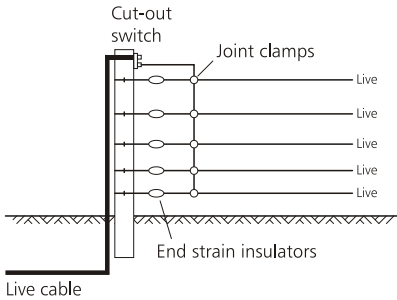

'Earth wire return' earth system

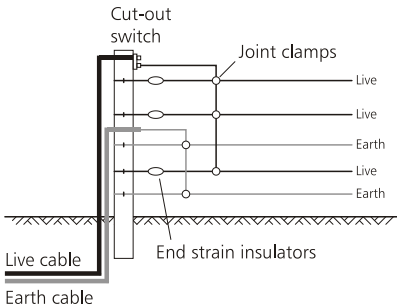

Gates

When by-passing a gateway it is essential to use high quality double-insulated underground cable encased in a high density polythene pipe. Bury the pipe at least 300 mm (12") deep. Turn the ends of the pipe down, well above ground level to keep water out.

Note:

- Ordinary non-insulated wire is liable to corrode over time when underground.
 - Low quality, thin cable can perish underground or may have insufficient insulation at high voltages. This will cause a drop in fence voltage or create a short-circuit.
-

Conventional gate

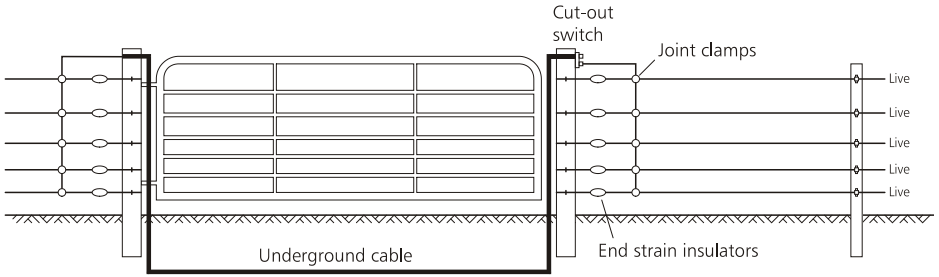

Spring (bungy) gate or tape gate

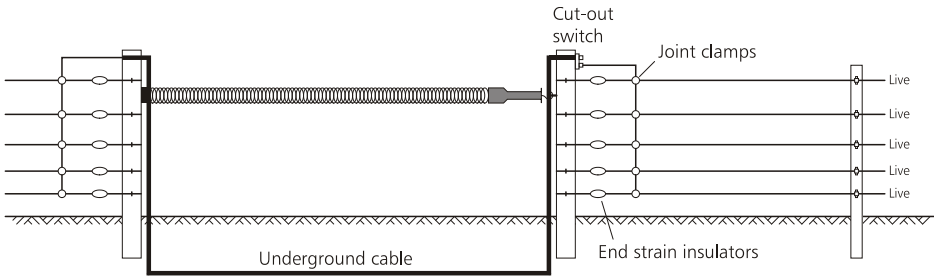

Earth wire return system gate

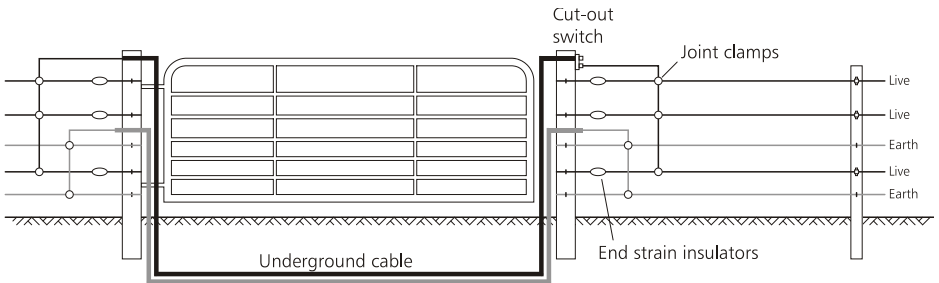

Lightning protection

Lightning will always find the quickest and easiest way to the earth. If this is through an unprotected electric fence, damage to the fence and energizer is likely.

In areas prone to severe lightning, a lightning diverter should be installed.

Lightning diverter

The lightning diverter has its own earthing system which must be installed at least 20 m (65') from the energizer's earth system. The lightning diverter's earth system must consist of more earth rods than the energizer's earth system.

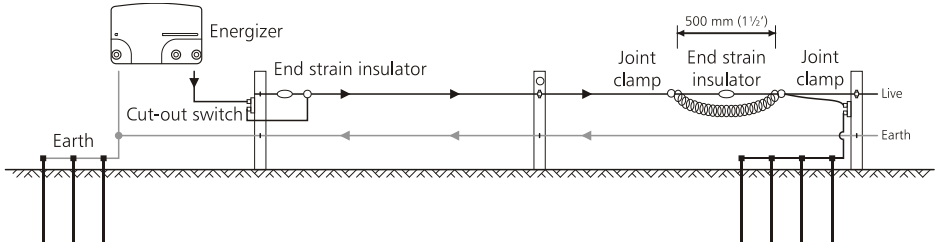

Additional ways to protect the fence and energizer

During an electrical storm, disconnect the energizer from the fence and earth system. Unplug a mains energizer.

If you have a mains/line energizer, install a voltage spike protector plug at the wall socket to protect the energizer from damage caused by surges of energy.

Note: No lightning protection can provide 100% protection, especially if the fence or energizer is subjected to a direct lightning strike.

Flood gates

An energy limiter can be used on a flood gate to prevent an entire fence from being shorted out during flooding. It limits the amount of energy on the flood gate during floods so that the remainder of the fence continues to have high voltage.

To construct a flood gate:

- 1 Drive two posts in on either side of the flood-way, above the highest flood level.
- 2 String a length of galvanized chain between the two posts with an insulator on either side.
- 3 Hang lengths of chain at 150-300 mm (6-12") intervals keeping ends approximately 200 mm (8") above average summer water level.
- 4 Connect an energy limiter from the fence to the fence.
- 5 Install a cut-out switch where water is likely to remain high for an extended period of time.

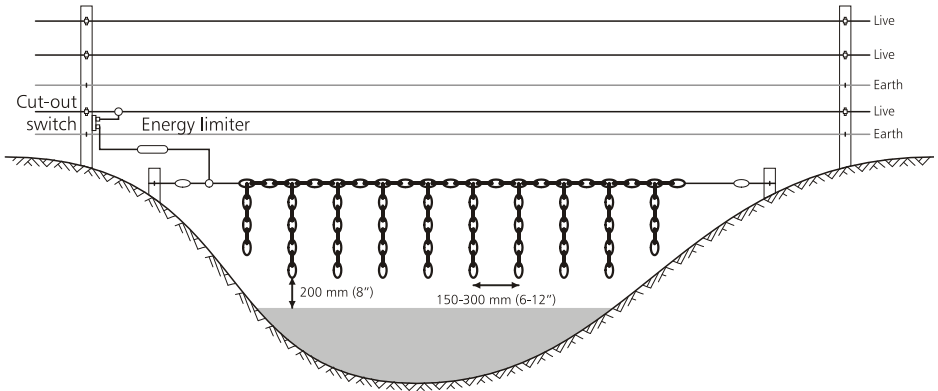

Electrifying a conventional fence

Older, non-electrified fences requiring replacement can be rejuvenated using insulated offsets (stand-offs) or outriggers and live wire. This will extend the life of the fence for many more years by preventing animals from leaning on the fence. The life of a new conventional fence can also be extended in this way.

To add offsets (stand-offs) or outriggers to a fence:

- 1 Restore an old fence by removing some of the worst wires or by tightening them sufficiently so that they will not cause the live wire to short.
- 2 Interconnect existing fence wires and use as earth wires in an earth wire return earthing system. See *Installing an earthing system* on page 8.
- 3 Install live wire on one or both sides of the fence.

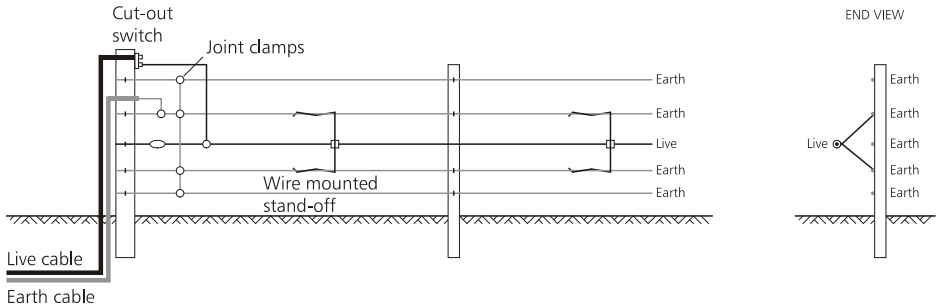

Subdividing the fence

Subdivision fences can be fed from the main fence. These fences should be kept relatively short to assist with possible fault finding later. Each connection should be made at one point only and should be fitted with a cut-out switch.

Temporary electric fence

Temporary electric fencing gives you the versatility to strip graze, make temporary paddocks or pens, and protect trees and crops from damage by stock and feral animals.

Strip grazing for controlled rotational grazing is an excellent method to improve pasture utilization. For best early regrowth of pasture, back-fencing of areas already grazed is recommended.

Generally, temporary fences are moved daily. The distance moved depends on the number of animals being grazed and the quality and quantity of pasture available.

Animals that are being fenced temporarily will require a portable water supply within the fenced area.

Post and wire spacings

Here are some suggested post and wire spacings.

Most of the fences below can have a 'ground earth return' or 'fence earth wire return' system of earthing. See *Installing an earthing system* on page 8.

Dairy Cattle

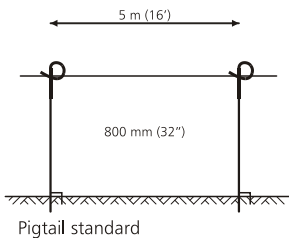

Cattle

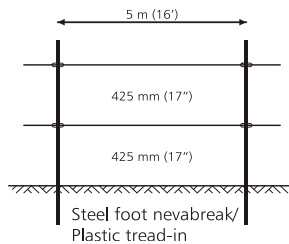

Sheep

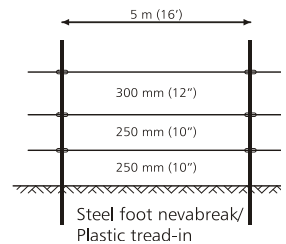

Temporary fencing wire/Poli-products

For temporary electric fencing, high-tensile wire is replaced with lightweight, flexible poli-product. Poli-products are constructed of multiple plastic threads, interwoven with several conductive metal strands and can easily be wound onto a reel.

There are a variety of poli-products available for use:

- Poliwire – Often used for strip-grazing, poliwire is ideal for setting up temporary electric fencing in areas which are prone to wind.
- Politape – Can also be used for strip-grazing. Available in 12mm and 40mm widths, politape provides increased visibility for animals and people. 40mm politape can also be used for gates and is also recommended for containing horses.
- Polirope and polibraid – Often used in semi-permanent fencing, polirope and polibraid provides a highly visible barrier for fast moving animals such as horses.

When selecting the right poli-product for your temporary electric fence, consider the following:

- The type of animal to be contained – poliwire is suitable for dairy cattle, cattle and sheep; politape, poliropo or polibraid is more suited for horses.
- The length of the temporary fence – longer lengths will require poli-products with low resistance/high conductivity. Look for poli-products with a combination of tinned copper (for ultimate conductivity) and stainless steel strands (for strength) for longer fence runs.

Choosing an energizer

How will you power your electric fence?

Battery	A battery energizer is ideal for powering temporary fences. Some battery energizers are compatible with solar panels to extend the life of the batteries.
Solar	Self-contained solar energizers have a built-in solar panel. These energizers are ideal for strip-grazing or powering fences in isolated areas.

Comparing energizers

When evaluating energizers, be sure to compare them on the same basis.

Output energy the amount of energy that is delivered to the fence.

Stored energy the amount of energy stored inside the energizer. This does not necessarily relate to the amount of energy that is delivered to the fence.

It is best to compare energizers by looking at the output energy.

Installing an energizer

Before installing the energizer make sure you have read all the instructions provided with your energizer.

Battery powered energizer

- Mount out of reach of children and animals.
- If necessary, build a protective box or fence around the energizer.
- If possible, position the energizer in the middle of the fence

Self-contained solar powered energizer

- Mount out of reach of children and animals.
- If necessary, build a protective fence around the energizer.
- If possible, position the energizer in the middle of the fence.
- Tilt the solar panel face the midday sun in winter.
- Adjust the solar panel to face north in the southern hemisphere and south in the northern hemisphere.

Visit www.tru-test.com to be connected to your preferred Tru-Test Group electric fence brand website, where you'll find more information about solar installations.

Strip grazing installations

Here are some suggested configurations for strip grazing:

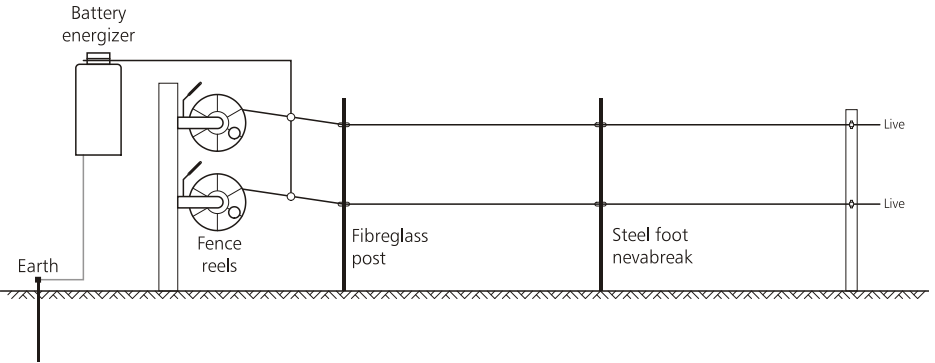
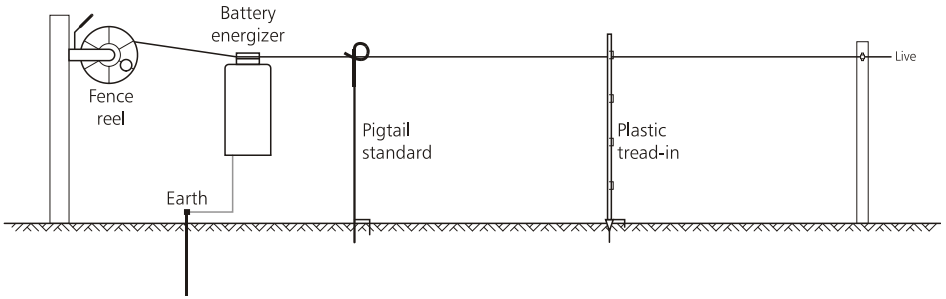

Fault finding

Faults (shorts) in the fence can reduce its effectiveness and may also cause other problems, such as interference on telephone lines or internet connections.

Causes for faults may include:

- Vegetation touching the live wires
- Broken wires or insulators
- Poor earthing
- Corroded metals somewhere in the fence-line
- Poor connections
- Poor insulation

Checking your fence regularly using a fault finder or a digital voltmeter is important in order to maintain an effective, problem-free electric fence installation.

Finding faults using a fault finder or digital voltmeter

Electrical current flows towards a fault (short) in the same way that water flows towards the plug-hole in a bath. A fault finder allows you to follow the direction of the current towards the fault, whereas a digital voltmeter allows you to test sections of the fence and isolate a faulty section.

Fault finder

To find a fault using a fault finder:

- 1 Check the energizer and the earth system.
- 2 Starting at the leadout, work your way along the fence taking readings at regular intervals. Always check around gateways, where fences intersect and wherever wires are joined, as faults are likely in these areas. A fault will show up as an abnormally high reading. A sudden reduction in current between one point and the next indicates a fault between the two points.

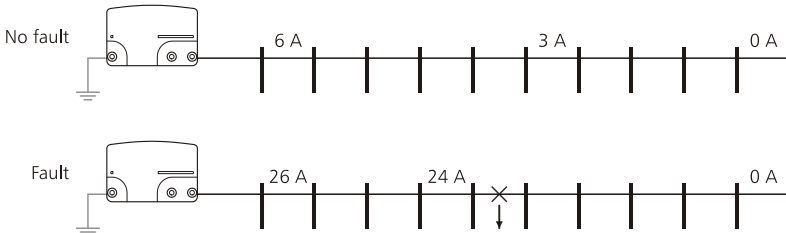

- 3 Move backwards in the direction of the highest reading to locate the fault.

Digital voltmeter

Tip: When using a digital voltmeter to find faults, isolate sections of fence-line with cut-out switches.

To find a fault using a digital voltmeter:

- 1 Check the energizer and the earth system.
- 2 At the first cut-out switch (at the end of the leadout), disconnect the rest of the fence and take a voltage reading. The voltage should be normal.
- 3 Move along the fence line, stopping at each cut-out switch. Take a voltage reading with the cut-out switch closed and again with the cut-out switch open. A spike in the voltage reading with the cut-out switch open indicates a fault in the section of the fence which has been disconnected (i.e. beyond the cut-out switch).
- 4 If you are still having trouble, follow the Troubleshooting flowchart on the following page:

Troubleshooting flow chart



Telecommunications interference

Sometimes, an electric fence can cause problems with a telephone line or an internet connection. Symptoms may include:

- Clicking noises on the phone line
- A slow or unreliable internet connection.

Faults can sometimes be hard to find because the problem fence can be anywhere between the telephone exchange and the phone line or internet connection with the symptoms. The fence owner may not suffer interference problems themselves, but neighbours might, even if they live several kilometers or miles away.

To resolve telecommunications interference problems, first check your own fence using the checklist below. If your fence proves to be OK, contact your neighbours and ask them to switch off their fences one at a time in order to isolate which fence is faulty. Check the faulty fence using the following checklist:

Checklist:

Find out where there are telecommunication cables or phone lines near your electric fence.

This includes buried and overhead wires and cables. Mostly, these run along or near the roadside reserve or along driveways. For assistance in locating telecommunication cables or phone lines, contact your nearest telecommunications company.

Identify potentially problematic electric fence wires and connecting leads.

Any electric fence wires and connecting leads within 100 m (330') of the phone lines or telecommunication cables can be potentially problematic, particularly if they are running parallel (or nearly parallel) to each other. Long sections of fence wire that feed other sections are more likely to cause problems than short sections that go nowhere else.

Check the current in these wires.

Use a fault finder to check measure the current in these fence wires. A good fence will measure no more than 2 amps per km (3 amps per mile) of energized fence line. If the reading is higher than this, there may be a short on the fence, there may be too much overgrowth, live wires could be contacting the ground, or insulators may have deteriorated.

If, after fixing faults, the current is still too high, find a way to feed the main power supply through sections of the fence that are further away from the phone line.

For example, feed the power out through fences in the middle of the farm, away from the phone line, rather than through a roadside boundary fence next to phone lines.

Check that the earthing system meets the requirements specified in your energizer's user manual.

All parts of the earthing system should be at least 10 m (33') away from buildings and other earthing systems. The earthing system should not be near a telephone line.

A good electric fence setup

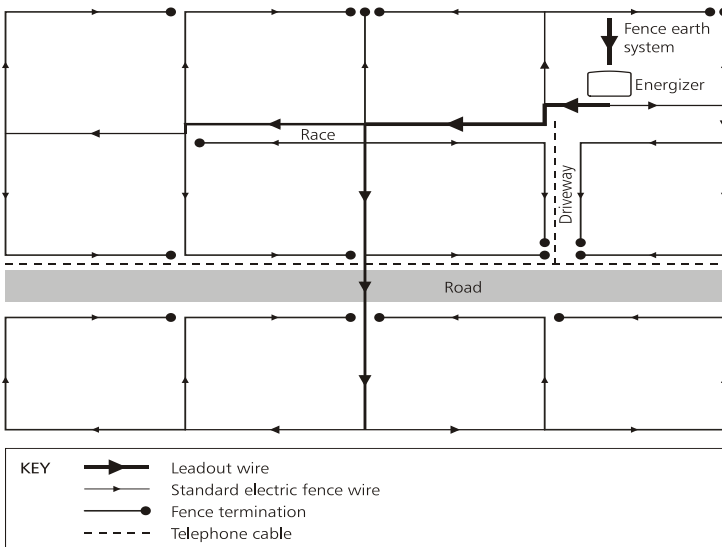

Note: Ideally the energizer should be placed in the middle of the fence, but this may not always be practical.

The ideal way to set up your electric fence is to feed the power out from the energizer in a 'star' fashion, with no closed loops and low currents in parts of the fence that closely parallel phone lines.

A poor electric fence setup

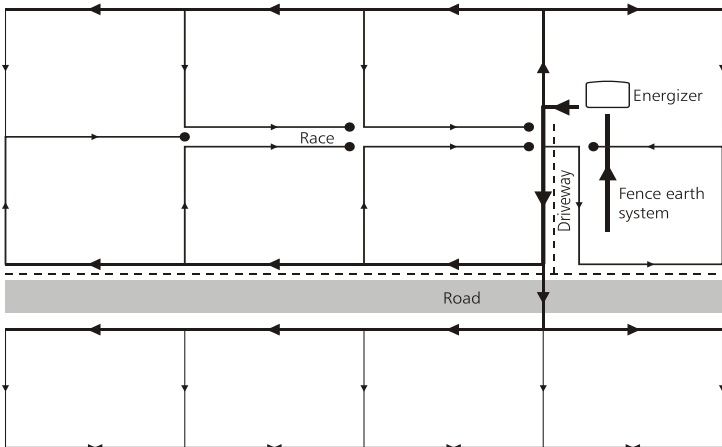

Tip: When buying a new computer modem, talk to the retailer about getting a product suited for use in a rural location.



For more information on Tru-Test Group
and our brands, visit www.tru-test.com

CONTACT:

NEW ZEALAND Tru-Test Group (Head Office), 25 Carbine Rd, Mt Wellington, Auckland.
Freephone: 0800 TRUTEST (878 837) •64 9 574 8888 Orders Facsimile: •64 9 574 8784.

AUSTRALIA Tru-Test Pty Ltd, Block 8 / 18 Torbey St, Sunnybank QLD, Australia.
Freephone: 1800 641 324 Orders Facsimile: 1800 831 847.

INTERNATIONAL Please see our website for contact details or contact
Tru-Test Group in New Zealand.

www.pel.co.nz